

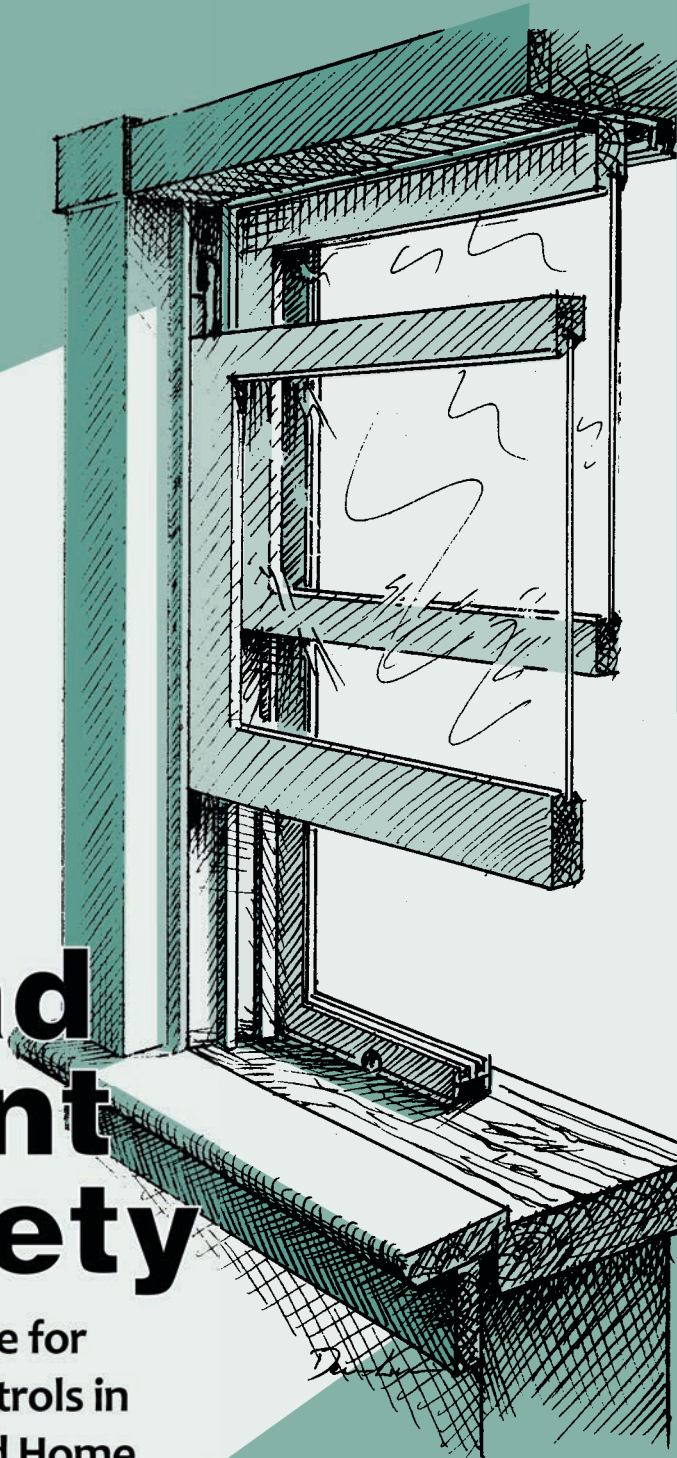

Lead Paint Safety

A Field Guide for
Interim Controls in
Painting and Home
Maintenance



U.S. Department of Housing
and Urban Development
Office of Lead Hazard
Control and Healthy Homes

WHO SHOULD FOLLOW THIS GUIDE AND WHY?



Maintenance and repair work on older homes (those built before 1978) can be very dangerous for you, the families who live in the homes you fix, and even your own family. Following this guide will help you lower lead-based paint exposure risks for you and the families, especially if you are a:

- Maintenance contractor
- Building maintenance staff
- Property manager or owner
- Homeowner hiring contractors or doing work on your own residences
- Local public housing agency staff
- Local public health agency staff
- Volunteer
- Contractor working on federally assisted housing

Why is knowing about controlling lead hazards important? Consider this case: A family purchased a two-family home built in the 1800s. The couple had two young boys, both less than 6 years old. As part of getting ready for them to move into the first-floor apartment, the parents repaired all deteriorated paint from it without considering lead dust control. They did not know about the dangers posed when lead dust is created and scattered during uncontrolled renovation. After they moved into the first floor, they renovated the upper floor before renting it out, also without considering lead dust control, further exposing their children to lead. Both children were found to have elevated blood lead levels a year after they moved in. If the family had known and acted upon the information in this guide, they could have prevented the harm to their children.



Most Old Homes Contain Lead-Based Paint

- Half the homes built before 1978 contain some lead-based paint.
- Lead-based paint is more common and was used more extensively in homes built before 1960.
- Homes built before 1960 also used paint that had a higher concentration of lead.



WHEN SHOULD I FOLLOW THIS GUIDE?

In pre-1978 homes and child-occupied facilities:

- To address an identified lead hazard.
- During routine maintenance or apartment turnover.
- Where there may be a young child or a pregnant woman.
- During work supported by federal funds that must be performed using safe work practices under federal regulations.

Note: This manual is not a substitute for training in renovation techniques by skilled tradespeople, such as apprenticeship programs.

Poor Maintenance Endangers Children

- In poorly maintained homes, lead-based paint, which may be several layers down, flakes and peels off. Paint failure is often caused by moisture problems.
- Renovation, repair and painting jobs disturb paint that may contain lead. Doing work improperly can cause a lot of dust.
- Lead-based paint chips and dust then mix with house dust and build up on horizontal surfaces such as window sills and troughs, and on floors.
- Children are endangered when lead in paint chips, dust, and soil gets on their hands and toys, which they may put in their mouths and ingest. Lead dust may be breathed or swallowed. Even small amounts of lead can affect children and cause permanent brain and nerve damage. It can also result in learning difficulties and behavior problems. This damage is irreversible.
- If paint is kept intact and surfaces are kept clean, children can live safely in a home containing lead-based paint.

- Uncontrolled or uncontained dust and debris from renovation, repair or painting that disturbs lead-based paint in a well-maintained home can also expose children to unsafe levels of lead that may be inhaled or swallowed.
- Flaking or deteriorating lead-based paint on a home's exterior can contaminate soil in the yard and be tracked into the home.

Lead-Safe Work Practices That Protect Workers and Children

- Lead-based paint can also pose a threat to workers by causing damage to their brains, and nervous and reproductive systems.
- Federal law requires renovation firms to be certified and renovators trained when working on homes and child occupied facilities built before 1978. Renovation firms must follow lead-safe work practices to protect themselves and their customers from lead exposure.
- These practices include:
 - Containing the work area.
 - Minimizing the dust.
 - Cleaning up thoroughly.
 - Verifying cleanup.

CONTENTS OF THIS GUIDE

1. The Basics	6
Work Practices Overview	6
Principles to Remember	7
Correcting the Cause of the Problem	9
Restricted Practices	11
Key Stages of a Job	14
2. Before You Start Work	15
Set Up the Work Area-Interior	15
Set Up the Work Area-Exterior	18
Worker Protection	20
3. Doing the Work	22
Interior Surface Prep	22
Exterior Surface Prep	24
Paint Removal	25
Damaged Interior Wall or Ceiling	28
Deteriorated Exterior Surfaces	30
Sticking Window	32
Loose Window	34
Window Won't Stay Open	36
Deteriorated Window Trough	38
Door Needs Adjustment	40
Door Rubs or Sticks	43
Chipping Paint on Stairs or Floor	45
If Nose Tread is Worn	46
Chipped or Damaged Impact Surfaces	48
High Dust Jobs	49
4. At the End of the Job	51
Cleaning Up	51
Disposal of Waste	54
Checking Your Work	56
Ongoing Monitoring & Maintenance	58
5. Resources	60
Federal Rules on Lead-Based Paint Safety	60
Glossary	62
For More Information	64
Contacts	66
Getting the Word Out	68
More About Technical Topics	73
Ensuring the Property is Clean	74
Worksite Checklists	77
Disclaimer	79
Why Follow this Guide	80

1. THE BASICS

WORK PRACTICES OVERVIEW



The main steps of these projects are listed here.

Correct the Cause of the Problem. Before work starts, correct the conditions causing damage to the home. See *Correcting the Cause of the Problem*, p. 9.

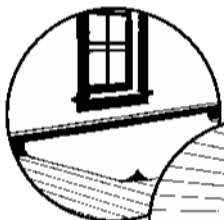

Set Up Work Area. Set up the work area properly. See *Set Up the Work Area – Interior and Exterior*, p. 15 and p. 18, respectively.

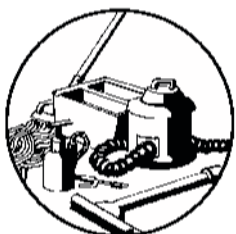

Clean Up and Clear. Thoroughly clean up the work area using the procedures described in this guide. Then, either wipe the surface and check for cleanliness or take dust wipe samples to see if it is safe for occupants to return. If federal funds are involved, clearance is required. See *Cleaning Up*, p. 51 and *Check Your Work*, p. 56.

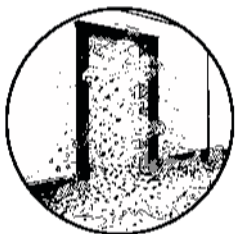

High Dust Jobs. Some activities are likely to create high amounts of dust during the job. See *High Dust Jobs*, p. 49 and follow the guidelines in this section to ensure that this work is performed safely.



Important!! This symbol points out important details where special attention is needed.

PRINCIPLES TO REMEMBER

1. ASSUME: Paint in Homes Built Before 1978 Contains Lead (*Unless a lead-based paint inspection shows it doesn't.*)

Exposing anyone to lead dust, especially children, is bad.

2. CHECK: Federal, State, and Local Regulations

- Take the 8-hour Renovation, Repair, and Painting ("RRP") certification training course
- Take appropriate refresher courses to keep your certification current
- Ensure your firm is certified. All firms that disturb paint in older homes and child occupied facilities likely require certification
- OSHA and some states have rules for worker safety
- EPA (or your state government) has renovation, repair and painting ("RRP") rules, training requirements, and certification for contractors and firms
- Your state or local government may have rules for waste disposal

3. AVOID: Creating Dust

- Follow lead-safe work practices to minimize creating and spreading dust
- Keep dust contained to immediate work area

4. PROTECT:

Occupants, Particularly Children

- Keep them away from work area
- Clean up work site before they return

Workers

- Wear proper respiratory protection for lead dust
- Keep clean
- Don't take dust home

5. CLEAN UP: After All Work

- Clean up is particularly important if the job generates high amounts of dust, such as demolition, window replacement or opening wall cavities
- At the end of the job, verify the area was cleaned adequately by either conducting cleaning verification – or taking and testing dust wipe samples to make sure that it is safe for occupants to return. If federal funds are involved, clearance is required

6. **MAINTAIN:**

All Painted Surfaces

- Well-maintained paint generally does not pose a health risk

Clean and Cleanable Surfaces

- Keep floors and painted surfaces clean
- Damp mop them often
- Clean rugs and carpet well

CORRECTING THE CAUSE OF THE PROBLEM

If a job involves repairs to a damaged paint surface, it is important to correct the cause of the damage, or the damage will occur again. Damaged surfaces that contain lead-based paint represent a health threat to the occupants.



The following conditions are examples of potential causes of damage to painted surfaces. Be sure that the planned work will correct these conditions if they are present.

Moisture From Outside

Roof leaks; incorrectly installed flashing; defective downspouts and gutters; water collecting in window troughs; puddles of water at foundations; leaking basement walls; wet crawl spaces.

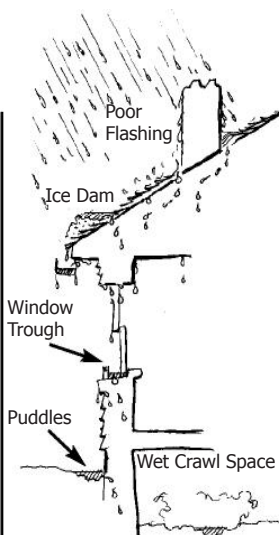

Moisture From Inside

Attic condensation due to poor ventilation; unvented steam from showers and cooking; leaking plumbing and failed seals around tubs and toilets; condensation in walls; unvented dryers; wet and poorly maintained basements.

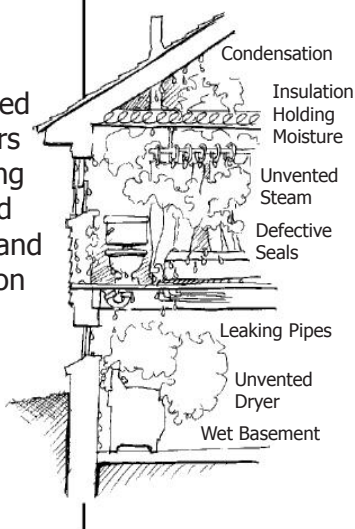

Rubbing and Impact of Painted Surfaces

Sticking doors; unprotected painted walls and trim; and rubbing from opening and closing painted windows.

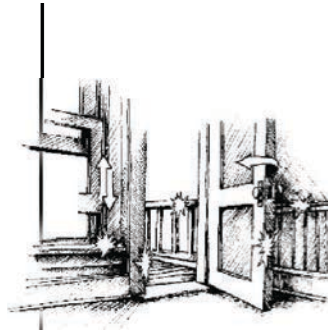

Places that Collect Dust and Paint Chips

Where feasible, repair or remove places where dust and paint chips may accumulate and can't be easily cleaned (such as old wall-to-wall carpet and unused items stored in the basement). If these places are damp, they may also be home to mold. Keep flat surfaces (such as window stools or interior sills and troughs) clean and cleanable.

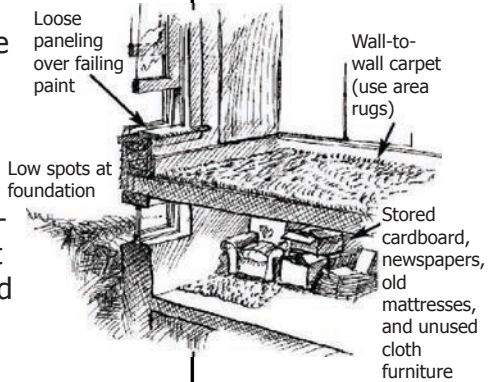

Structural Damage

Some surface damage may be caused by structural damage, such as wood rot, termite infestation, foundation settlement, and foundation shift. These problems must be addressed before surface repairs are made.

RESTRICTED PRACTICES

Goal:

Don't use unsafe work methods. Some work methods create such high levels of dust that they are prohibited from use when working on surfaces that may contain lead-based paint. The following work practices are prohibited by both HUD and EPA. *Additional practices are prohibited in federally assisted work by HUD, see p. 12.*



Don't Use Power Sanders, Needle Guns or Grinders without a High Efficiency Particulate Air (HEPA) Vacuum Attachment.

These machines create a lot of dust that can contaminate a building and the ground around a building endangering workers, neighbors, and occupants.



Controlled Sanding, Needle Gunning or Grinding with HEPA Vacuum Attachment Is Acceptable.

If the sanding or grinding machines are "shrouded," which means surrounded with a barrier that prevents dust from flying out around the perimeter, AND attached to a HEPA vacuum, they can be used if no visible dust or release of air occurs. It is recommended workers wear properly rated respirators, such as an N100, R100, or P100, identified in RRP training. Respirators may be required based on the amount of dust created. *See Glossary, p. 62.*



Don't Use Open Flame/High Heat Removal of Paint.

There is no acceptable use of an open flame torch or high temperature heat gun (above 1100 degrees F) to remove paint.

- It produces toxic gases that a HEPA dust canister on a respirator cannot filter out on its own (a second, organic filter is necessary).
- It creates high levels of very toxic dust that is extremely difficult to clean up.
- It can burn down a house.



Do Use a Heat Gun on Low Setting.

A heat gun set below 1100 degrees F may be used with caution. It is recommended for small areas only, such as the edge of a door, the top of a window stool, or the friction surface of a window jamb.

Additional activities are prohibited by HUD; these prohibitions do not apply to work that is not federally assisted.



Don't Use Paint Strippers Containing Hazardous Chemicals.

Many paint strippers contain hazardous chemicals. For example, strippers containing methylene chloride should not be used because this chemical is extremely toxic and is known to cause cancer.



Paint Strippers without Hazardous Chemicals Are Acceptable.

Chemical paint strippers without hazardous chemicals, such as methylene chloride, are safer to use, as long as the precautions printed on the container are followed. Take extra precautions to mask areas near stripping.



Don't Use Uncontained Hydroblasting.

Removal of paint using this high-pressure water spray method can spread paint chips, dust, and debris beyond the work area. This result makes it difficult to clean up these hazards at the end of the job.



Contained Pressure Washing Is Acceptable.

Removal of paint using contained pressure washing within a protective enclosure to prevent the spread of paint chips, dust, and debris may be done. Because this method requires additional precautions that are beyond the scope of this guide, it should only be used by certified lead abatement workers.



Don't Use Uncontrolled Abrasive Blasting (Sandblasting).

This work method can also spread paint chips, dust, and debris beyond the work area. This result makes it difficult to clean up these hazards at the end of the job.



Contained Blasting Is Acceptable.

Contained abrasive blasting within a protective, locally exhausted enclosure to prevent the spread of paint chips, dust, and debris may be used. Because this method requires additional precautions that are beyond the scope of this guide, it should only be used by certified lead abatement workers.



Avoid Extensive Dry Scraping or Sanding.

Extensive dry scraping or sanding creates large amounts of paint chips, dust, and debris that are hard to contain.



Use Wet Methods or Limited Dry Scraping and Sanding.

Mist surfaces before scraping and sanding. Continue to mist while working. Dry scraping or sanding of very small areas (for example, around light switches or outlets) may be done if flat surfaces below these areas are covered with protective sheeting. These methods should be avoided on areas larger than 2 square feet per room, and workers must have adequate respiratory protection.

KEY STAGES OF A JOB

Quality work requires thinking through the job from start to finish. Here are the basic stages of the jobs described in this guide.

- | | |
|--------------------------|---|
| Before Starting | <ul style="list-style-type: none">• Find the causes of damage• Test to determine if lead paint is present or assume lead paint is present and adhere to all lead safe work practice requirements• Prioritize work• Hand out the Lead-Safe Certified Guide to Renovate Right pamphlet (<i>see p. 70 for more information</i>) |
| Work | <ul style="list-style-type: none">• Set up work area<ul style="list-style-type: none">- Separate work space from occupied space- Isolate high dust areas• Correct cause(s) of problem(s)• Complete the job using safe work practices, such as those shown in this guide |
| Finish the Job | <ul style="list-style-type: none">• Clean up thoroughly• Dispose of waste safely and according to federal and state requirements• Check quality of work and correct problems |
| Maintain the Work | <ul style="list-style-type: none">• Educate occupants about risks from lead-based paint• Maintain the paint in good condition |

2. BEFORE YOU START WORK

SET UP THE WORK AREA — INTERIOR

Restrict Access

- Have occupants leave the room where work will be done (pets included).
- Have them stay out until the job is done.
- Place 'Warning: Lead Work Area' sign in the language of the occupants.



Caution: If the work will create a large amount of dust, follow the guidelines on High Dust Jobs, p. 49.

Protect Floor

- Cover the floor with taped down plastic sheeting extending at least 6 feet from the area paint is being disturbed or a sufficient distance to contain dust, whichever is greater. The area where the floor is covered is the work area.

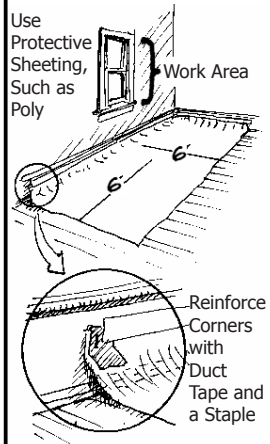

Protect Furnishings

- Remove objects from the work area (e.g., drapes, curtains, furniture, and rugs).
- Cover and seal objects that can't be removed with taped impermeable protective sheeting.

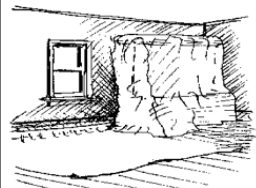

**Protect
Furnishings
(Cont)**

- Close windows in the work area.
- Doors used to enter the work area must be covered with plastic sheeting in a manner that allows workers to pass through while confining dust and debris, see p. 50. All other doors in the work area must be closed and covered in plastic sheeting.
- Close and cover all duct openings in the work area with taped down plastic sheeting.

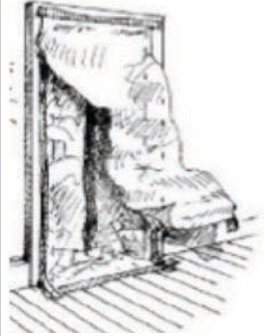

**Stock the
Work Area**

- Put all necessary tools and supplies on protective sheeting before beginning work, to avoid stepping off the protective sheeting. *For high dust jobs, see p. 49.*



**Prevent
Tracking
Dust**

- To avoid tracking dust off the protective sheeting, wear non-skid shoe covers on protective sheeting and remove them each time you step off the protective sheeting.



OR

Prevent Tracking Dust (Cont)

- Wipe both top and bottom of shoes with a damp paper towel each time you step off the protective sheeting.

OR

- Clean off the soles of shoes using a tack pad (a large sticky pad that helps remove dust).

OR

- Use a HEPA vacuum to clean off shoes and clothing prior to leaving the work area.

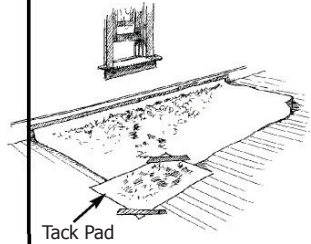

Set Up Dust Room (Optional)

- When working on components that can be moved, such as doors and window sashes, consider setting up a dust room to contain dust and paint chips. This is an isolated area where workers can do dust generating work and make clean up easier. *See High Dust Jobs, p. 49.*

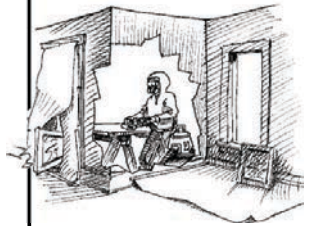

SET UP THE WORK AREA — EXTERIOR

Protect the Ground

- Cover the ground with plastic sheeting extending at least 10 feet from the area paint is being disturbed or a sufficient distance to collect falling paint debris, whichever is greater.
- If the edge of the property is within 10 feet, then build a vertical containment or take similar precautions to prevent contamination of surrounding buildings and property.

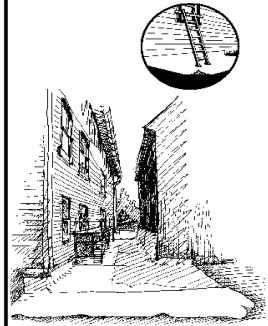

Important: Covering the ground protects the soil from contamination by lead-based paint chips and dust.

Attach Protective Sheeting to Wall

- Protective sheeting can be taped and/or stapled to wood siding or ribbon board. A wood strip may need to be attached to a masonry wall.

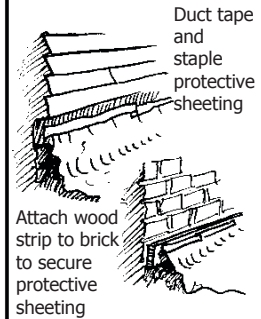

Build Curb

- Build a curb around work perimeter when a sidewalk or another property is near, or when wind may blow debris off protective sheeting.

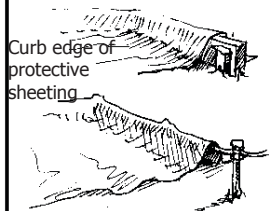

Caution: This may pose a tripping hazard.

Cover Windows and Doors

- All windows and doors within 20 feet of the work area must be closed. If they cannot be closed, seal with protective sheeting during work.
- If an entrance must be used that is closer than 20 feet, place a shroud above and on the sides of the entrance that allows workers to pass through while confining dust and debris.

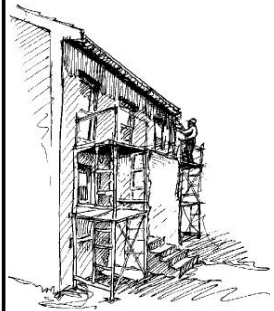
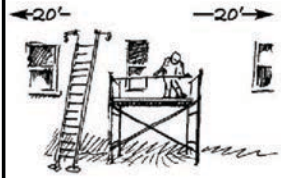

Construction Safety

- You should be concerned about other general construction hazards. Go to OSHA's website (www.osha.gov) to learn more about these and other construction safety topics:
 - Scaffolding
 - Fall protection
 - Ladders
 - Head Protection
 - Hazard Communication
 - Construction
 - Electrical
 - Slips, trips and falls

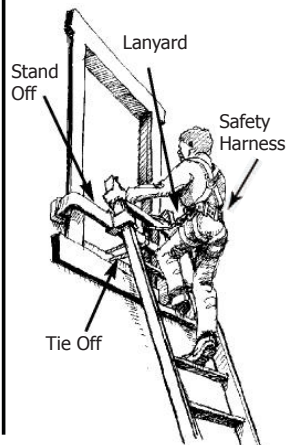
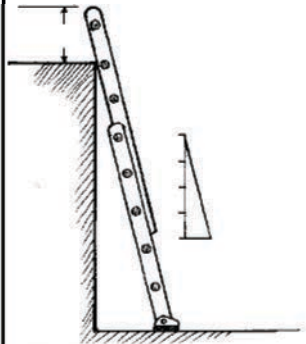

WORKER PROTECTION

Protect Your Eyes

- Workers should wear safety goggles or safety glasses when scraping, hammering, etc.



Keep Clothes Clean

- All personnel, tools, and other items must be free of dust and debris when leaving the work area.

OR

- At the end of every work period and each time you exit the work area, remove dusty clothes and/or HEPA vacuum off dust. Wash them separately. Do not use compressed air to blow dust off clothing.

Use Disposable Covers

- Wear disposable protective clothing covers. Disposable protective clothing covers can be stored in a plastic bag and reused if fairly clean and there are no rips. Small tears can be repaired with duct tape.
- Wear painter's hat to protect head from dust and debris.



**Wear
Respiratory
Protection**

- When work creates dust or paint chips, workers should wear at least a NIOSH-approved respirator for lead work. *See Respiratory Protection, p. 73.*



**Post
Warning**

- Post 'Warning: Lead Work Area' sign and avoid eating, drinking, or smoking on site.

Sign at
Work
Entrance

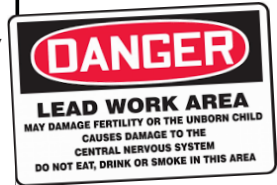

Wash Up

- Wash hands and face each time you stop working.

3. DOING THE WORK

INTERIOR SURFACE PREP

PROBLEM: A wall or ceiling is sound, but has holes, uneven surfaces, or flaking and peeling paint.

SOLUTION: Prepare wall or ceiling to create a sound, intact surface for painting. Use methods that create a minimum amount of dust.

Set Up

- See *Set Up the Work Area - Interior*, p. 15.



Remove Deteriorated Paint

- Wet scrape any loose, peeling, or flaking paint.

Fill and Patch Holes

- If removal of damaged edges is necessary, mist surface before removal.
- Skim and fill holes and cracks less than 1/16-inch wide with a non-shrinking spackle compound.
- If sanding is necessary to feather edge, use wet abrasive sponge or wet-dry sandpaper with water.



Prep Surface

- Clean wall, particularly in kitchen area.

Prep Surface (Cont)



- De-gloss surfaces as necessary (use liquid sandpaper or wet-dry sandpaper with water).

Important: Allow surface to thoroughly dry before priming.

- Prime surface using high-grade primer.
- Apply top coat. Use one or two coats as necessary.
- See *Cleaning Up*, p. 51 & *Check Your Work*, p. 56.



Clean Up and Clear

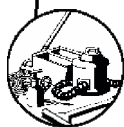

EXTERIOR SURFACE PREP

PROBLEM: Exterior wood surface is chipping and peeling and may be painted with lead-based paint.

SOLUTION: Prepare a sound, intact surface for painting. Use methods that create minimal dust.

Set Up

- See *Set Up the Work Area - Exterior*, p. 18.



Clean Surface

- Clean wood with detergent (or lead-specific cleaner) and scrub brush.

Wet Scrape

- Wet scrape woodwork and siding. Mist small areas frequently to keep down dust. Using a pump sprayer in a knapsack is convenient.

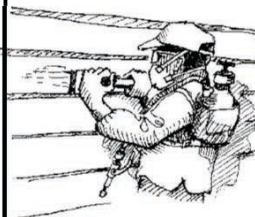

Mist and Sand

- Wet sand using wet-dry sandpaper or wet sanding sponges. A power sander may be used if attached to a HEPA vacuum, and the worker is wearing respiratory protection.

Paint

- Prime and paint.

Clean up and Clear

- See *Cleaning Up*, p. 51 & *Check Your Work*, p. 56.

Dispose of Waste Water

- If you dislodge paint using pressure washing, water must be collected and may need to be tested before disposal (see local regulations for water disposal procedures in your area).

PAINT REMOVAL

PROBLEM: Areas of paint are peeling or flaking or there is evidence that a child has been chewing on a painted surface. An example of a surface accessible to children is the inside nose of a window stool (inside sill).

SOLUTION: Remove all paint using methods that do minimum harm to the surface, create minimal dust, and are safe for workers.

Set Up

- See *Set Up the Work Area - Interior & Exterior*, p. 15 and p. 18, respectively.
- When using chemical strippers, the edge of the protective covering below the painted surface must be tightly fastened to the wall so that the stripper doesn't damage other surfaces.

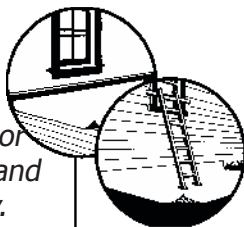

Recommendations:

- Use a second layer of protective sheeting to collect stripping waste. The first layer remains in place to protect surfaces below.
- For removable components, consider having paint stripped off-site or installing an entirely new component.

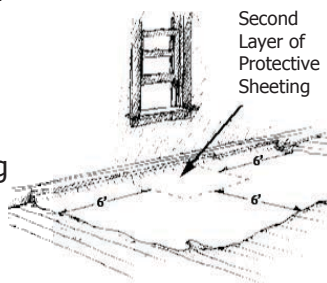

Chemical Removal

- If a large area of paint is to be stripped, consider hiring a professional.
- Follow the manufacturer's instructions carefully when using chemical paint strippers.
- Ensure there is lots of ventilation into the work area exhausting fumes to the outside.



Caution: *If using a caustic stripper, neutralize the surface according to the manufacturer's directions before applying new paint.*

- After stripping paint from wood, a paint residue will remain in the wood. Use caution when sanding the bare wood because it may contain lead residue.



Hand Stripping

- Paint can also be removed with a paint scraper. Be sure to mist areas where paint is to be removed. Using a hand plane removes all paint and all residue. It also creates very little dust.

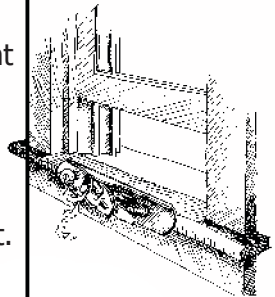

Mechanical Stripping

- When using power tools, such as sanders or grinders, to remove or feather paint, make sure the tool is shrouded and attached to a HEPA vacuum. Respiratory protection is still necessary.

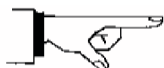
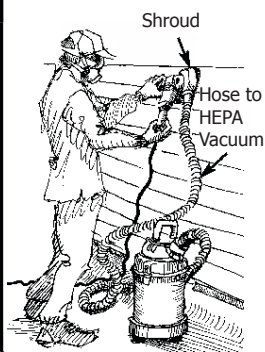

Caution: High dust potential.



Heat Stripping

- When using a heat gun to remove paint, be sure the temperature setting is kept below 1100 degrees F.

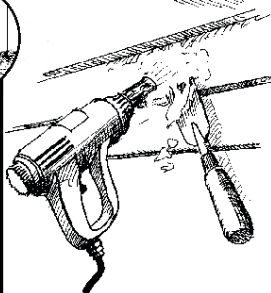

Clean Up and Clear

- See *Cleaning Up*, p. 51 and *Check Your Work*, p. 56.



DAMAGED INTERIOR WALL OR CEILING

PROBLEM: Wall or ceiling area is too badly damaged to repair, and demolition would create a large amount of dust.

SOLUTION: Install a new durable surface over the damaged area using methods that create little dust and do not require demolition.

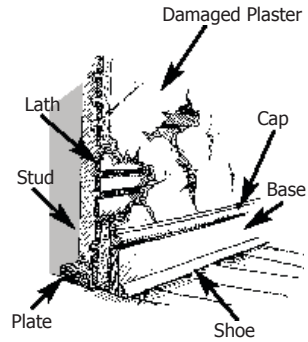

Set Up

- See *Set Up the Work Area - Interior*, p. 15.

Cover with Drywall

- Mechanically fasten drywall or veneer board through damaged plaster to studs.
- Seal the perimeter, particularly the bottom edge.

On Base

- Avoid removing existing base.



Caution: High dust potential.

- Where drywall laminate will end above existing base, install shoe or cove molding into bead of caulk to seal.
- If laminate comes close to flush with base face, a strip of lattice bedded in caulk can be used to seal joint.

Drywall Laminate Sits on Old Base

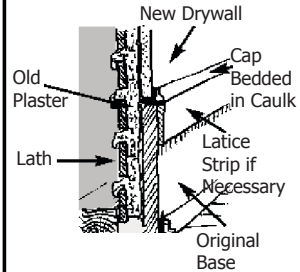

New Base Over Drywall Laminate

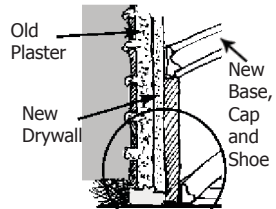

Old Plaster New Drywall Laminate

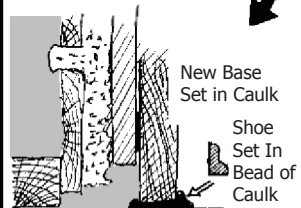

Behind Base

- Where base will be replaced, bed the new base in a bead of caulk on the back and bottom. Then, bed shoe molding in a bead of caulk to seal.
- Bed the lower edge in a bead of caulk with a trim piece also bedded in caulk.
- Finish top with cap molding.

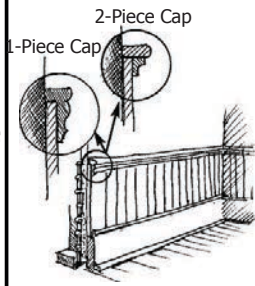

Repair Holes in Ceilings

- When laminating drywall to ceilings, it is critical to screw into joists, not lath.
- Old joists may be irregularly spaced, so each joist center must be located.
- A drywall dagger can be used to find the joist edge, or a heavy gauge wire pushed through the plaster.
- The drywall edges should be taped and spackled.
- If walls will not be spackled, perimeter edges can be finished with "J" channel bedded in a bead of caulk.

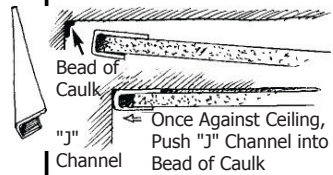
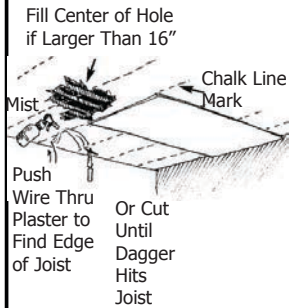

Clean Up and Clear

- See *Cleaning Up, p. 51* and *Check Your Work, p. 56*.



DETERIORATED EXTERIOR SURFACES

PROBLEM: An exterior painted surface is badly damaged.

SOLUTION: Whenever possible, repair the surface, prep, prime, and paint exterior trim and siding, and then maintain the surface. This method is the preferred approach.

When a surface is too badly damaged to repair, install vinyl or aluminum siding, or aluminum wrap to create a safe, durable covering that protects the surface and does not cause further deterioration.

Note: Siding must be installed correctly, or wood rot and/or interior paint failure may occur. Siding may also become home to insects and mold. Correct installation is critical in both hot and cold climates.

Cover Deteriorated Surface with Siding

Set Up

- See *Set Up the Work Area - Interior & Exterior*, p. 15 and p. 18, respectively.

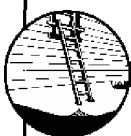

Install Siding

- Carefully follow the manufacturer's instructions for installing siding over an existing surface.
- Use a styrene backboard with an insulation rating of at least R2.
- Take care to properly install flashing, especially at horizontal trim and window and door heads.

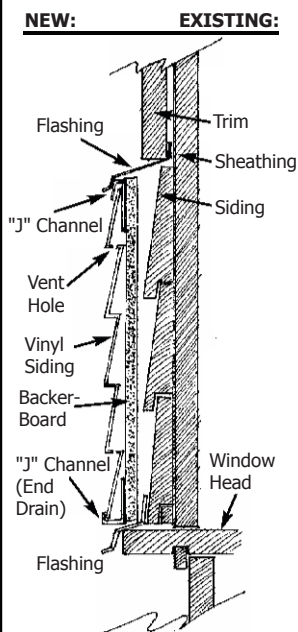

Install Siding (Cont)

- The siding system must be well vented but sealed at the bottom to prevent flaking and peeling paint from falling from behind the siding to the ground.
- Be sure that water can drain out.



Important: *The entire home should be well ventilated to prevent moisture build-up that can cause structural damage and/or paint failure.*

Clean Up and Clear

- See *Cleaning Up*, p. 51 and *Check Your Work*, p. 56.

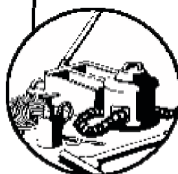

STICKING WINDOW

PROBLEM: Window sticks, and paint on window is flaking.

SOLUTION: Remove window, scrape or plane, repaint, and reinstall, OR install a new window.

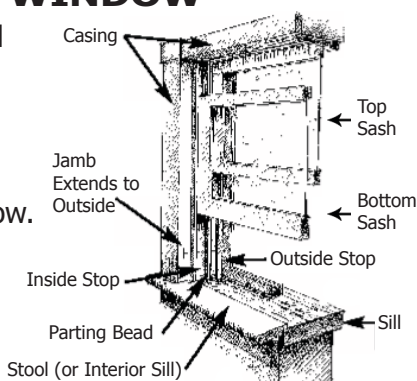

Set Up

- See *Set Up the Work Area - Interior*, p. 15.



Loosen Painted Sashes

- If window is painted shut, mist and cut window joint with utility knife. Then open joint between sash and stop with a "window opener." Mist while working.

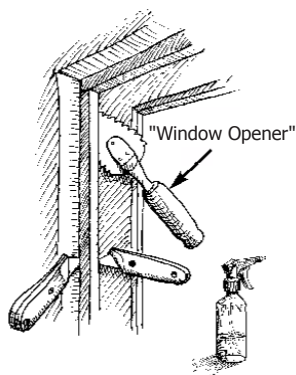

Remove Inside Stop Molding

- Mist and remove stop molding from sides and head. Dispose of properly unless it has historic value.

Remove Bottom Sash

- If counterweight cord or chain is attached to the sash, knot it or tie it to a stick when removing from sash so it does not get pulled into the weight compartment.

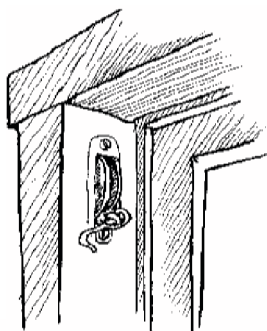

Remove Top Sash

- Mist and remove parting bead. Then remove the top sash.

Wet Scrape or Plane



- Set sash on a work bench, clamp it, and wet scrape all surfaces. Or use a power planer attached to a HEPA vacuum.

Wet scrape these ridges of paint

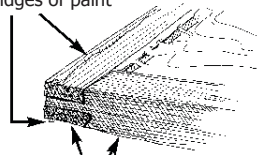

Seal this bottom edge very well, particularly the end grain. Use linseed oil or other sealant

Caution: High dust potential. This work can be done in a dust room. See *High Dust Jobs*, p. 49.

Repair, Re-glaze, Seal, and Paint



- Re-glaze and repair as necessary. Wet sand, prime, and paint sash and jamb. Seal, but do not paint sash edges.

Important: Seal bottom edge of sash, particularly end grain.

Repair and Paint Jamb

- Repair jamb if necessary.
- To prevent dust and chips from falling outside the window, install a scoop of protective sheeting.
- Then wet scrape, prime, and paint.
- Reinstall sash with new or wet scraped and repainted stop and parting bead.

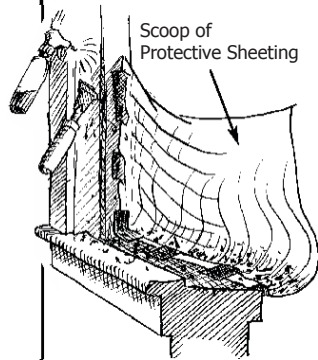

Clean Up and Clear

- See *Cleaning Up*, p.51 and *Check Your Work*, p. 56.

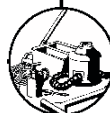

LOOSE WINDOW

PROBLEM: Loose sashes (lower and upper) do not operate smoothly, and they allow heat loss. Also, sashes rubbing against a painted jamb create paint dust.

SOLUTION: Install sashes in window compression jamb liner to seal window and allow sashes to move easily without rubbing against jamb. If sashes or window components are badly deteriorated, replace window.

Install Window Jamb Liners

Set Up

- See *Set Up the Work Area - Interior*, p. 15.

Remove Sashes and Paint

- Follow directions on p. 32.

Cut Jamb Liners

- Cut liners to fit in jamb (1/4-inch short of dimension). If pulley system is being saved, cut off directly below pulley.

Install Jamb Liners

- Press jamb liners onto sash.
- Attach jamb liners with brass screws on top and bottom of each side.

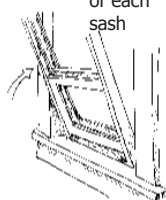
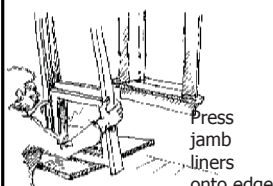
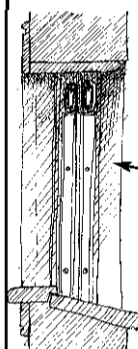
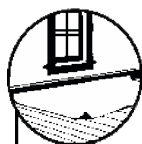

Install Stop Molding

- Install new inside stop molding tight against jamb liner.
- If top sash is painted shut and is to remain fixed, adjust the above steps as follows:
 - Cut away flange between channels of jamb liner.
 - Leave parting bead intact and install bottom sash as above.

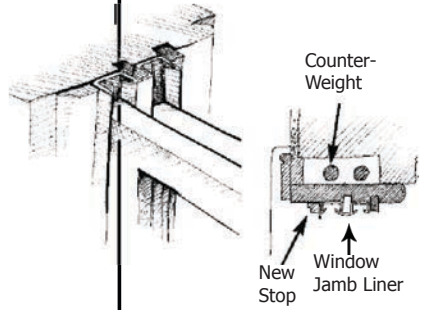

Cut flange of jamb liner with Plexiglas cutter.



Replace Sash/Window

Choose an Option

- If the sashes or other components are too badly deteriorated to save, consider one of the following options:
 - Install new sashes in tilt-in jamb liners.
 - Replace sashes, stops, and parting bead with a vinyl or aluminum window unit.
 - Replace entire window including jamb casing, stool, and apron.

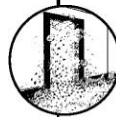

Clean Up and Clear

- See *Cleaning Up*, p. 51 and *Check Your Work*, p. 56.

WINDOW WON'T STAY OPEN

PROBLEM: Window sash is loose and won't stay up without support. Propping the window open presents a danger to occupants, particularly children. When a window jamb liner is used, it may not be sufficient to keep the window open (see p. 34).

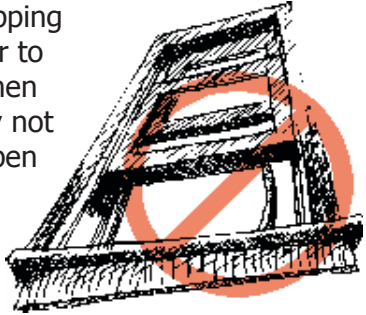

SOLUTION: Repair counterweight system or install hardware so the window will stay open securely or replace window.

Set Up

- See *Set Up the Work Area - Interior*, p. 15.

Option #1: Reinstall Counterweight System

Open Counter-Weight Panel

- Find top of panel. Mist and scrape paint from top edge to find screw or nail holding in panel. Remove screw and pry off panel.

Vacuum

- Vacuum weight compartment with HEPA vacuum.

Remove Counter-Weight System

- Remove old rope or chain from counter-weight and edge of sash.

Reinstall Counter-Weight System

- Cut chain so weight is above bottom of weight compartment when open and weight is below pulley when closed.

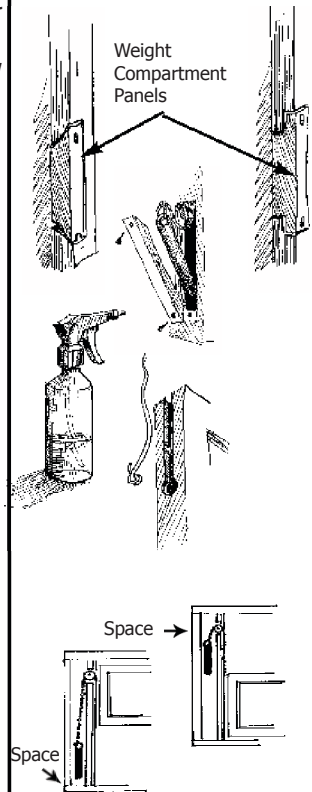

Reinstall Counter Weight System (Cont)

- Drop chain over pulley into weight compartment, pull out through panel opening, and attach to weight.
- Attach other end to edge of window sash using spring fixture. You may want to secure chain with fence staple.

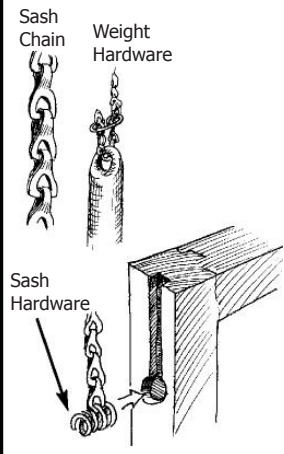

Option #2: Install Spring Clips

Install Spring Clips

- Screw spring clips on to window as directions indicate (2 styles shown).

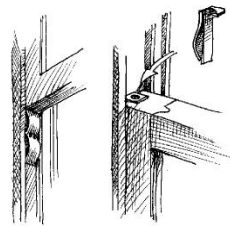

Option #3: Install "Hold Open" Hardware

Install Slide Bolt

- Screw slide bolt to bottom of window sash. Tap bolt to mark where you want to drill holes for bolt. Drill holes in inside stop at 3 or 4 points.

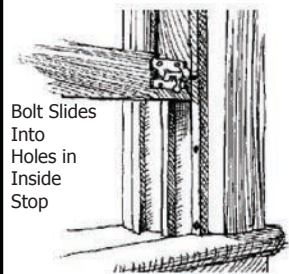

OR

Attach Hardware

- Attach hardware that uses spring to press against stop. To move sash, press lever. Release lever when window is at desired height.



Clean Up and Clear

- See *Cleaning Up*, p. 51 and *Check Your Work*, p. 56.



DETERIORATED WINDOW TROUGH

PROBLEM: Storm window traps water behind the frame causing paint deterioration and damage to the sill.

SOLUTION: Drill a drain hole through bottom of the storm window frame.

PROBLEM: Window trough surface is damaged and difficult to clean.

SOLUTION: Install smooth and cleanable surface in window trough.

BEFORE

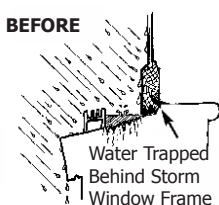

AFTER

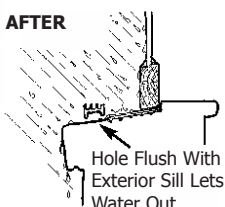

Set Up

- See *Set Up the Work Area - Interior*, p. 15.

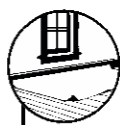

Drill Drain Hole

Drill

- To allow drainage, drill 2 holes through frame of storm window flush with sill. Drill holes approximately one quarter of the way from both sides. First, drill a 1/8-inch pilot hole, then the 3/8-inch hole.

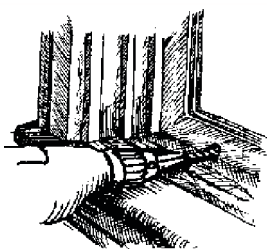

Dent

- If flashing is installed in window trough and covers any part of the drain hole, run awl through drain hole. Tap with hammer to form dent in flashing to drain out water.

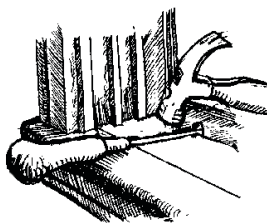

Wet Scrape

- To make surface flat, wet scrape high points and remove any fasteners from trough.

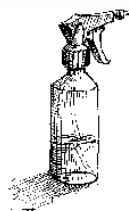

Cut

- Cut flashing ¼-inch shorter than the width and length of trough.

Chisel or Notch

- To allow flashing to fit tight to jamb, drive chisel under parting bead and outside stop — or notch each side of the flashing at these two points.

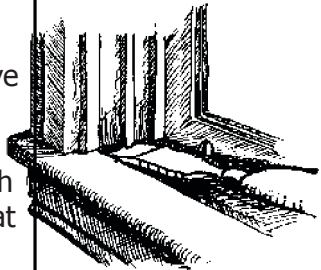

Check Fit

- Then slide flashing in to check fit. Remove and trim if needed.

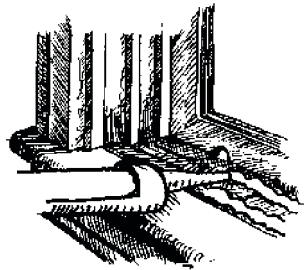

Fasten

- To fasten flashing, run bead of adhesive caulk around perimeter of trough.

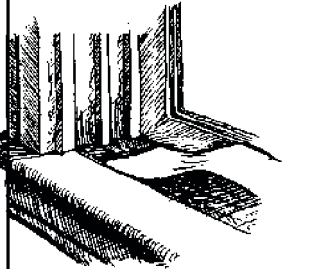

Install Flashing

- Bed flashing in adhesive caulk bead and press down.

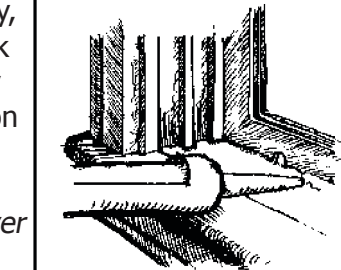

Seal

- Run a bead of caulk around perimeter of flashing. If necessary, wipe off excess caulk with damp cloth. Try not to smear caulk on face of flashing.



Important: Do not cover drain hole with caulk.

Clean Up and Clear

- See *Cleaning Up*, p. 51 and *Check Your Work*, p. 56.

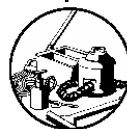

DOOR NEEDS ADJUSTMENT

PROBLEM: Edge of door is crushing against jamb on hinge side; or door is rubbing on latch side because hinges are loose. When paint on a door rubs or is crushed, dust and paint chips can result.

SOLUTION: Adjust the door so that it opens and closes without damaging painted surfaces.

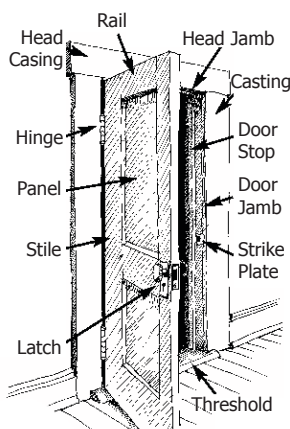

Set Up

- See *Set Up the Work Area - Interior*, p. 15.

Check Door

- Grasp knob and try to move door up and down. If hinges are loose, door will move.

Remove Screws

- Remove screws that are most loose, but not all screws, so door remains hung.
 - Clear paint from screw notch with hammer and small screwdriver.
 - Unscrew. If screw head is stripped, use screwdriver bit in a brace.

Fill Hole

- Drive 3/16-inch or 1/4-inch dowel into screw holes as necessary to fill each hole. Cut dowels flush.

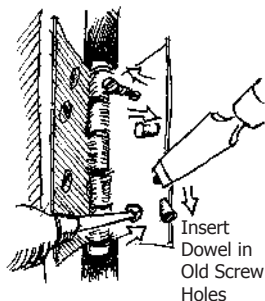
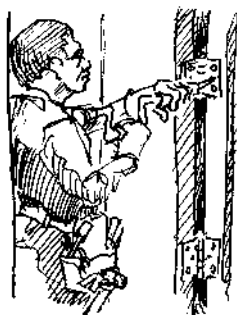
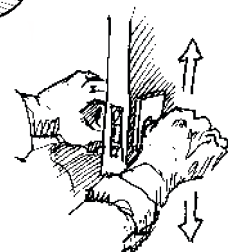
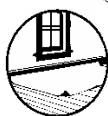

Install New Screws

- Replace screws. Use longer screws if necessary. Using a screwdriver bit on a brace makes this easier. Then remove and replace remaining screws as necessary.

Adjust Stop

- Face of door should only contact the stop on the latch side of door frame. It should not crush or rub head or hinge side stop.
- Where stop is nailed, remove and replace with new matching stop. Leave 1/8-inch space between hinge, head stop, and the face of the door.

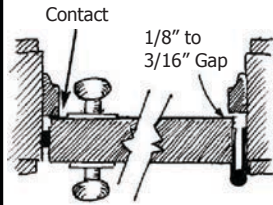

Check Perimeter of Door for Clearance of 1/8" to 3/16"

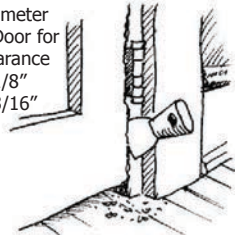

Check Clearance

- If putty knife can't fit in gap between door and jamb at all points, crushing of painted surfaces may be occurring.

Adjust Depth of Hinge Leaf

- If door is crushing hinge side and there is more clearance than necessary on the latch side, install metal shims behind hinge leaves. Keep at least 1/8-inch clearance on leaf side and 1/8-inch clearance on latch side. *If not enough clearance, see p. 43.*

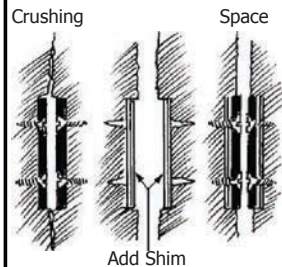

Adjust Depth of Hinge Leaf (Cont)

- If only a small increase is needed between leaves of hinge to create a gap between door edge and jamb, place a steel rod between hinge leaves near pin and close door to slightly bend apart leaves.

Use Steel Rod (Like
Screwdriver) to Bend
Open Hinge Stock

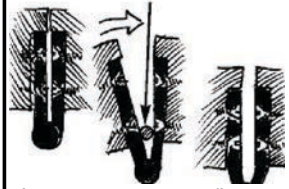

(Drawing is Exaggerated)

Clean Up and Clear

- See *Cleaning Up*, p. 51 and *Check Your Work*, p. 56.



DOOR RUBS OR STICKS

PROBLEM: Door is scraping on latch side; or door is crushing jamb on latch side and there is not enough clearance on latch side to add shims to hinges. When paint on a door rubs or is crushed, dust or paint chips can result.

SOLUTION: Plane edges of door so that it operates smoothly and does not rub.

Set Up

- See *Set Up the Work Area - Interior*, p. 15.

Remove Hinge Leaves

- Remove pins from hinges and hinge leaves from door.
- Set door on edge in a door hold.
- Mist surface and hand plane a chamfer edge.

Hand Plane Edge

- Use a smooth bench or jointer plane (not a block plane) to remove the rest of the paint from the edge. Continue to mist while working. If a power planer is used to remove paint it must be attached to a HEPA vacuum. Some power planers need an adaptor to accept HEPA attachments.

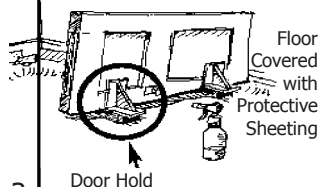

Hand Plane Edge (Cont)

- Once paint is removed, use either a hand or power planer.

Re-Cut Hinge Gains

- Then, re-cut hinge gains as necessary so hinge leaf is set about halfway into gain.

Seal Edges

- Seal edges of door, particularly the bottom, and re-hang.

Clean Up and Clear

- See *Cleaning Up*, p. 51 and *Check Your Work*, p. 56.

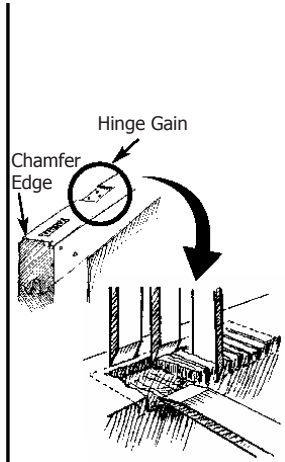

CHIPPING PAINT ON STAIRS OR FLOOR

PROBLEM: Painted staircase treads, risers or floors are worn, or the paint is chipping. Paint and other coatings used on staircases and floors in older homes often contain lead. Everyday friction and wear can produce paint chips and dust.

SOLUTION: Cover portions of stairs or floor that are worn with durable material.

Set Up

- See *Set Up the Work Area - Interior*, p. 15.

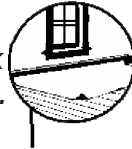

Stairs – Option #1: Install Tread Covers and Riser Enclosures

Wet Scrape

- Mist and wet scrape any loose paint on treads and risers, particularly on edges.

Prime and Paint

- Prime treads and risers. Paint edges that will not be covered by enclosures.

Install Riser Enclosure

- Cut 1/4-inch luan plywood to fit each riser. Sand exposed edges of luan.

Fasten

- Back caulk perimeter of riser with adhesive caulk. Press tight or nail with finish nails.

If nose tread is not worn:

Cut and Install Tread Cover

- Cut cover to fit over the tread and nose.
- Install cover with adhesive caulk or screws.

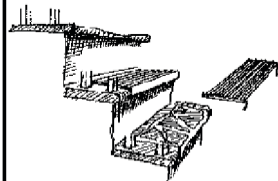
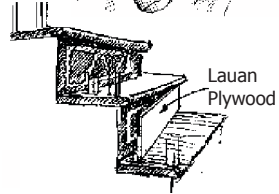
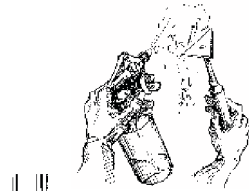
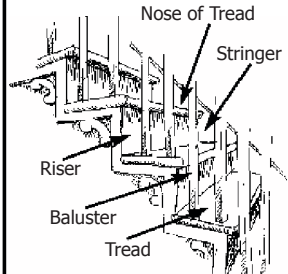

IF NOSE TREAD IS WORN

PROBLEM: Installing a rubber tread over a worn tread nose creates a hollow space under the rubber tread cover. This can cause the rubber tread cover to tear, posing a tripping hazard.

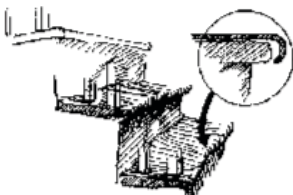

SOLUTION: Install a tight-fitting nose tread, or install a staircase runner.

Cut and Install Tread Cover

- Cut tread cover to fit from the riser to rear edge of nose. Install with adhesive caulk or screws.

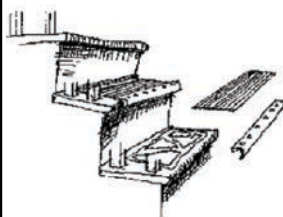

Install Metal Nose Cover

- Screw metal cover over edge of tread nose. It will span the worn area of the nose.

Stairs – Option #2: Install Staircase Runner

Wet Scrape

- Mist and wet scrape any loose paint on tread and riser, particularly on edges.

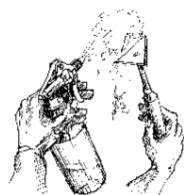

Prime and Paint

- Prime and paint treads and risers.

Install Runner

- Staple runner to top of top riser. Then fasten with staircase bars so runner may be easily removed for cleaning.

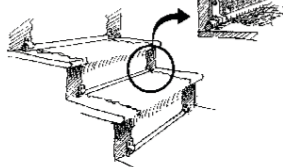

Important: Do not install runner or tread cover on landing of upper floor where its rear edge may become a tripping hazard.

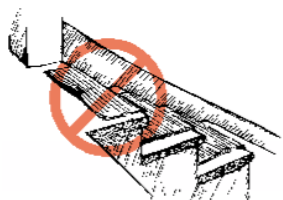

Floors

Prep Surface

- If a floor needs to be refinished, use a floor sander attached to a HEPA vacuum.



Caution: High dust potential.

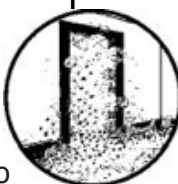

Cover

- Apply a coating to the floor to keep it smooth and cleanable.
- To maintain a smooth and cleanable surface, it is recommended that the use of wall-to-wall carpeting be avoided. Area rugs can be used instead.

Clean Up and Clear

- See *Cleaning Up*, p. 51 and *Check Your Work*, p. 56.



CHIPPED OR DAMAGED IMPACT SURFACES

PROBLEM: Outside corners of walls, edges at passages, as well as trim, base cap, and shoe molding are being chipped due to impact from doors, furniture, and other objects. If these surfaces are covered with lead-based paint, the paint chips and the dust created may pose a health threat.

SOLUTION: Protecting these surfaces with a durable material can prevent the creation of paint chips and dust.

Set Up

- See *Set Up the Work Area - Interior*, p. 15.

Enclose Outside Corner

- Cover outside corners of walls with corner molding. Attach with nails and/or with a bead of adhesive.

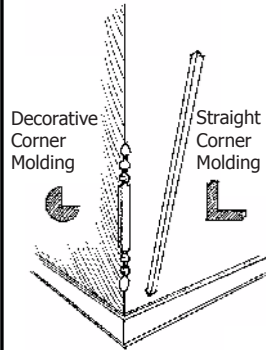
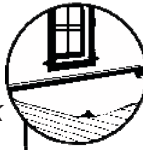

Protect Base

- In places where a baseboard shows signs of impact, replace shoe and protect cap with lattice strip.
- When replacing shoe, bed new shoe in bead of caulk to seal out moisture and prevent infiltration of dust.

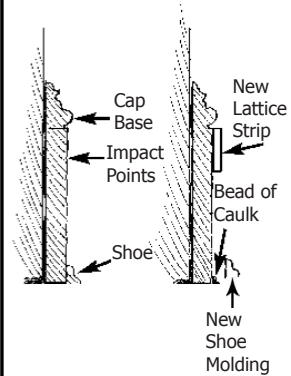

Clean Up and Clear

- See *Cleaning Up*, p. 51 and *Check Your Work*, p. 56.

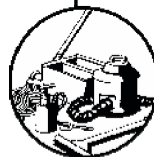

HIGH DUST JOBS

Some jobs create large amounts of dust. To be safe, workers doing this type of work should:

1. Wear half-mask respirators rated as N100, R100, or P100 (or HEPA) at a minimum and be trained to wear and maintain them or conduct air monitoring to show that they are not needed (*see Respiratory Protection, p. 73*).
2. Completely isolate the work space from occupied spaces and use containment to protect other workers (*see next page*).



Remember: All house dust is unhealthy to breathe. It may contain lead, mold, asbestos, gypsum, roach waste, dust mites, coal dust, fiberglass, etc.

Jobs that require containing an entire room or group of rooms are high dust jobs. The following types of work are likely to create high levels of dust:

Examples of High Dust Jobs

Demolition. Demolition includes tearing off siding and/or demolishing old plaster walls or ceilings.

Opening Up Wall Cavities. These jobs include:

- Removing old paneling, baseboards, or wood trim
- Removing door casings or frames
- Removing window casings, jambs, or frames

"It's not just what's on the wall, it's the dust inside it."

Removing Old Drop Ceilings. Lots of dust can accumulate above ceiling panels.

Improperly Removing Wall-To-Wall Carpet. A carpet that's been on the floor for many years has gathered large amounts of household dust, which may include lead dust. Improperly removing it can release a large amount of dust.

Paint Scraping. Scraping large painted areas, such as the side of a house or an entire room, even when done correctly, can create a large amount of dust.

Dust Containment at Doors

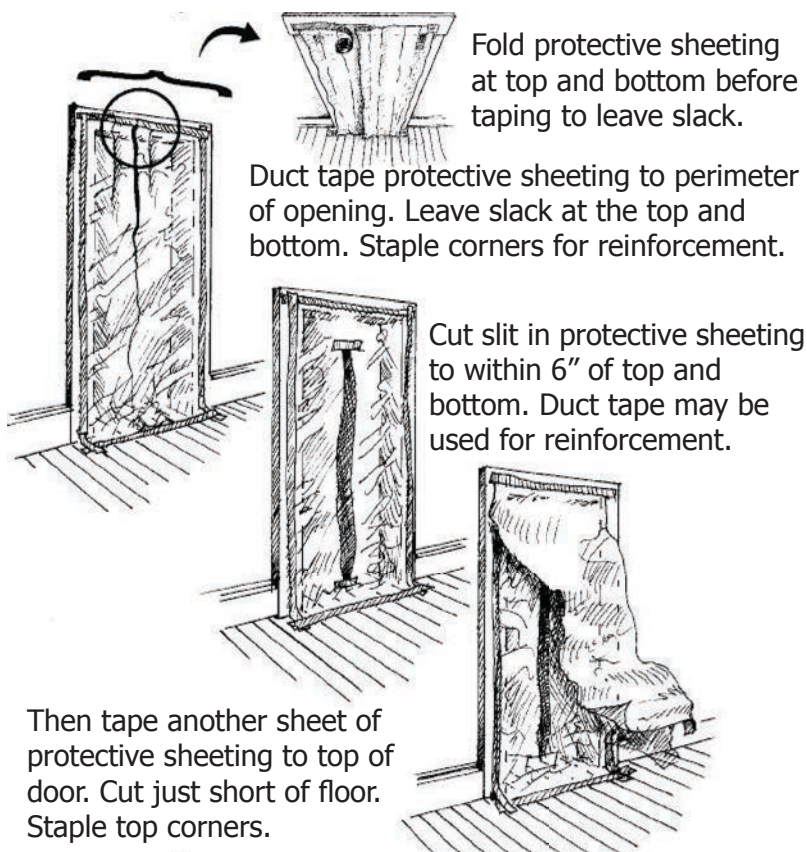

In addition to the steps outlined in the section on setting up the work area, high dust jobs require containment of doors that allow access but prevent the migration of dust.

Use this system to keep dust from spreading to another room.

4. AT THE END OF THE JOB CLEANING UP

It is very important to use proper cleanup procedures at the end of every day and at the end of the job. Dust and paint chips left behind may contain lead and may endanger children.

On a daily basis, you should:

Pick Up Work Area

- Pick up as you go.
- Put trash in heavy-duty plastic bags.
- Vacuum the work area with a HEPA vacuum cleaner frequently.
- Clean tools at the end of the day.
- Wash up each time you take a break and before you go home.
- Dispose of or clean off your personal protective equipment.
- Remind residents to stay out of the work area.

When the job is complete:
Interior work:

- Pick up large chips with damp paper towel, **AND/OR**
- Mist then push dust into dust pan.
- Seal it in a heavy-duty bag.

Pick Up Protective Sheeting

- Clean off protective sheeting. Mist the sheeting before folding it dirty side inward, and either tape shut or seal in a heavy-duty bag. Dispose of protective sheeting as waste at the end of each job.

Make Dust Pan
from Flashing
and Clean with
a Whisk
Broom

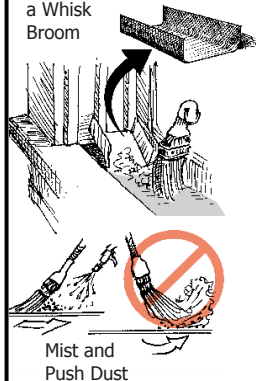

HEPA Vacuuming, Misting and Scrubbing

- Clean walls starting at the ceiling and working down to the floor by either vacuuming with a HEPA vacuum or wiping with a damp cloth.
- HEPA vacuum all remaining surfaces and objects in the work area, including furniture and fixtures.

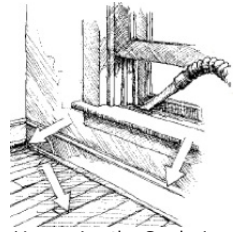

Vacuuming the Cracks is Very Important



Important: Vacuum carpet very slowly.

- Damp wipe all remaining surfaces and objects in the work area, except for carpeted or upholstered surfaces. Mop uncarpeted floors thoroughly using a mopping method that keeps the wash water separate from the rinse water or using a wet mopping system.

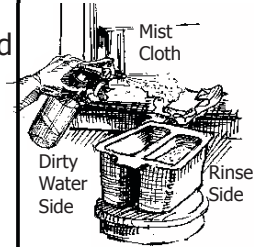

Exterior work:

- Collect all paint chips and debris, and seal it in a heavy-duty bag.
- Clean off protective sheeting. Fold dirty side inward (dirty side to dirty side) and dispose of protective sheeting as waste.

Rinse Rag

- Squeeze rag into empty side of split bucket. Rinse out rag. Squeeze into empty side. Repeat as needed.
- Change rinse water often.
 - Use paper towels first if surfaces are very dirty.
 - Replace rag when it looks dirty.
- Clean until dust and debris are removed.



Cleaning Floors

Mist and Scrub

- At start of cleaning, soak mop in detergent water then mist small area with detergent before mopping.
- Scrub with mop.



Squeeze Out and Wash

- Squeeze mop into empty bucket. Rinse in rinse water. Rinse often. Squeeze out and rinse again. Mop small areas at a time.

OR



Rinse and Dispose of Waste

- Repeat above process using clean water rather than detergent. When cleaning up a work site, use a new mop head for rinse stage.

OR

For Large Jobs

Recommendation: Make a final pass with a HEPA vacuum.

- See *Ensuring the Property is Clean*, p. 74.



DISPOSAL OF WASTE

After cleanup of the work area, take care to safely handle and remove dust and debris from the job. Supervisors should check with the EPA and their state's agency responsible for waste to find out about specific federal, state, and local regulations regarding disposal of waste that may contain lead-based paint.

Key Principle: Confine Dust and Waste to the Work Area That Will Be Cleaned

Disposal Practices

Specific guidelines are:

Waste from Renovations

- Waste from renovation activities must be contained to prevent releases of dust and debris.
 - Collect and control all your waste including dust, debris, paint chips, protective sheeting, HEPA filters, dirty water, cloths, mop heads, wipes, protective clothing, respirators, gloves, architectural components, and other waste.
 - Use heavy plastic sheeting or bags to collect waste. Seal the bag securely with duct tape. Consider double bagging waste to prevent tears. Large components must be wrapped in protective sheeting and sealed with tape.
- Bag and seal all waste before removing it from the work area.
- At the end of each work day and at the conclusion of the renovation, waste that has been collected from renovation activities must be stored to prevent access to and the release of dust and debris.
- Waste transported from renovation activities must be contained to prevent release of dust and debris.

Disposal Practices (Cont)

Dispose of Waste Water Appropriately

- Water used for cleanup should be filtered and dumped in a toilet if local rules allow. If not, collect it in a drum and take it with you. Never dump this water down a storm drain, or on the ground. Always dispose of waste water in accordance with federal, state and local regulations.

Be Aware of Waste Disposal Rules

- Because EPA considers most residential renovation and remodeling as "routine residential maintenance," most waste generated during these activities is classified as solid, non-hazardous waste, and should be taken to a licensed solid waste landfill. This is not the case for work done in commercial, public or other nonresidential child-occupied facilities, where waste may be considered hazardous and require special disposal methods. For further information, go to www.epa.gov/lead/regulatory-status-waste-generated-contractors-and-residents-lead-based-paint-activities.
- Always check state and local requirements before disposing of waste. Some are more stringent than federal regulations.

CHECKING YOUR WORK!

Check Quality of Work & Cleanup

Check work quality **during the job** and at the **end of the job**.

- **If there were any problems, were the causes of the problems corrected?**
- **Were proper work practices used?**
- **Was cleanup done thoroughly?**

How to Check

Checking your work involves two important steps.

1. Visual Checks

Follow the Ensuring the Property is Clean section (*p. 74*) when performing visual checks.

- **During the Job.** Be sure that:
 - the cause of the problem is being corrected;
 - the work area is safely set up;
 - the practices in this guide are being used; and
 - dust and debris are not spreading beyond the work area.
- **End of the Job.** Be sure that the repairs were done properly and that no dust or paint chips remain.

2. Perform Cleaning Verification

EPA's Renovation, Repair and Painting (RRP) rule requires contractors to follow a specific cleaning verification protocol. They use disposable cleaning cloths to wipe the floor and other surfaces of the work area and compare these cloths to an EPA-provided cleaning verification card to determine if the work area was adequately cleaned. *See p. 74 for more information.*

3. Take a Dust Wipe Sample

For work in homes receiving federal assistance or when otherwise requested/required, when interior work disturbs painted surfaces or produces dust, dust wipe samples must be taken and analyzed at the end of the job to check for harmful levels of lead-contaminated dust.

3. Take a Dust Wipe Sample (Cont)

Dust wipe testing is recommended at the end of any job that disturbs paint or produces dust, especially when:

- Work that disturbs paint is done in homes built before 1978.
- A young child or pregnant woman lives in the home.
- Performing unit turnover or regular maintenance in rental properties.

See p. 75 for more information

Why Is It Important to Check Work

Checking that work was done properly is important because:

- Failing to correct conditions causing damage or deterioration results in repairs that do not last.
- Work that fails to follow the recommendations in this guide may spread dust and paint chips beyond the work area and may endanger children in the home.
- Dust and paint chips left behind due to poor cleaning may contain lead and may also endanger children in the home.
- For contractors, checking your work improves the quality of a job and is likely to reduce the risk of a lawsuit in the event a child in the home is later found to have high levels of lead in his/her blood.

ONGOING MONITORING & MAINTENANCE

Regularly Check Repairs for Deterioration, Paint Chips, and Dust



Maintain Required Certification and Training

Maintain Surfaces and Thoroughly Clean

Methods of Monitoring

Property owners should regularly monitor painted surfaces where maintenance or improvements were performed.

Check to see if:

- New evidence of deterioration or paint failure is present.
- The cause of the problem was corrected.
- Dust lead hazards are present.

Important: *This can only be done by dust wipe sampling.*

- Contractors hired to do work disturbing lead paint are certified as a firm, and their workers must be trained. When a housing property owner's staff does the work, the property owner must be certified as a renovation firm, the employees supervising the work must be certified as renovators, and the employees doing the work must be trained by the supervisors in lead-safe renovation.

Then:

- Perform repairs, as needed, to maintain surfaces in a smooth and cleanable condition using the methods recommended in this guide; and
- Clean the area thoroughly using the practices described earlier in this section.

Follow the same methods used to check your work:

- **Visual Check.** Look for deterioration, paint failure, dust and paint chips. Use the checklist inside the back cover of this guide.
- **Test for Lead Dust.** Have dust wipe samples taken to check for dust that may be contaminated with lead. A test is needed to determine when dust contains harmful amounts of lead.

Methods of Monitoring (Cont)

To be accurate, these tests must be done according to specific procedures. *See p. 75 for more information about these tests, and who should perform them.*

When to Monitor?

It is important to monitor the results of the work to ensure that it is still effective. The monitoring times below are recommended (they are required for federally assisted housing):

- **During Unit Turnover, Routine Maintenance, or when Tenants Provide Information about a Problem with Painted Components.** Perform a visual check for deteriorated paint, and the condition of past repairs and improvements involving painted surfaces.
- **Annually.** Perform a visual check for deteriorated paint, and the condition of past repairs and improvements involving painted surfaces.
- **Every Two Years.** Along with the annual visual check, get a dust wipe test done at least every two years. This type of test is strongly recommended when a young child or pregnant woman lives in the home.

Why Is It Important to Monitor & Maintain Work?

Monitoring and maintenance help:

- Plan and implement maintenance tasks.
- Protect occupants and neighbors, particularly children, from lead exposure.
- Give owners, contractors, and residents a record of the condition of the unit.

5. RESOURCES

FEDERAL RULES ON LEAD-BASED PAINT SAFETY

There are federal and state rules governing different aspects of lead-based paint safety. Here is a brief overview of the federal laws regarding lead-based paint in housing. You should check applicable state and local rules and comply with the most stringent rules.

Lead Disclosure Rule (EPA and HUD): Before you rent or buy most pre-1978 homes or apartments, the seller or landlord must disclose available records, reports, and information on lead-based paint and lead-based paint hazards. The sales contract or lease must include a specific warning statement about lead-based paint, and if you are buying the home, you have up to 10 days to check for lead. The rule is located in two places, [title 24 of the Code of Federal Regulations \(CFR\) part 35, subpart A \(HUD\)](#) and [40 CFR 745, subpart F \(EPA\)](#).

The Lead Safe Housing Rule (HUD) applies to most federally assisted pre-1978 housing. Depending on the nature of the maintenance, rehabilitation or abatement work, and/or the amount of federal funds, certain lead-based paint safety actions must be taken. This HUD rule says when and how properties should be evaluated for lead-based paint and/or lead-based paint hazards. Lead-based paint on the inside and outside of the building needs to be stabilized or abated, and clearance – a check by a risk assessor and a lead laboratory on whether the work area is safe to occupy again – must be performed for all but the smallest amounts of work. Also, the rule outlines how owners or managers must handle cases where a child with an elevated blood lead level lives in an assisted property. [24 CFR 35, subparts B - R](#).

The Renovation, Repair and Painting (RRP) Rule (EPA) applies to firms performing RRP projects that disturb paint, in most pre-1978 housing or pre-1978 child care facilities and pre-schools. These firms must be certified by EPA (or an EPA authorized state), use certified renovators who are trained by an EPA (or state) accredited RRP training provider, use workers who are trained in lead-safe work practices by either an accredited RRP training provider or their supervisor, and follow lead-safe work practices, including procedures outlined in this guide, and additional procedures in [40 CFR 745, subpart E](#).

Lead Worker Protection Rules (OSHA) cover [Lead in Construction, 29 CFR 1926.62](#) and [Lead in General Industry, 29 CFR 1910.1025](#). These regulations cover federal requirements for worker protection in the construction, remodeling, renovation, and maintenance industries. In addition, some states have worker protection rules covering lead exposure protection.

To find these regulations online, go to www.eCFR.gov and search or browse for the regulation you want.

GLOSSARY

Child-occupied facility - a pre-1978 building, or part of one, visited regularly by a child under age 6, such as a child-care center or pre-school.

Enclosure - a rigid, durable construction material that is mechanically fastened to the structure to cover painted surfaces.

HEPA filter - High-Efficiency Particulate Air filter. A filter that can remove particles of 0.3 micrometers or larger from the air at 99.97 percent or greater efficiency.

HEPA vacuum - a vacuum with a HEPA filter.

HUD Guidelines - HUD's Guidelines for the Evaluation and Control of Lead-Based Paint Hazards in Housing.

Interim controls - a set of measures to temporarily reduce exposure to lead hazards. Interim control measures include special cleaning, repairs, paint stabilization, enclosure, and containment. For a full discussion, see the HUD Guidelines.

N100, R100, or P100 - a filter class that describes a respirator's ability to filter airborne particles. A respirator filter rated as N100, R100, or P100 removes particles of 0.3 microns or larger from the air at 99.97 percent or greater efficiency. An N filter does not filter oil; an R filter is resistant to oil; a P filter is oil proof.

NIOSH - National Institute for Occupational Safety and Health, an agency within the Centers for Disease Control and Prevention that tests and certifies safety equipment including respirators.

OSHA - Occupational Safety and Health Administration, an agency of the U.S. Department of Labor that oversees worker safety and health.

Paint stabilization - a process of wet scraping, priming, and finish coating of a deteriorated painted surface to prevent further deterioration.

Protective sheeting - made of plastic, poly or other material. Protective sheeting must be puncture and tear resistant, impermeable to liquids, and durable (cloth or canvas sheets are not acceptable as protective sheeting).

RRP – EPA’s Renovation, Repair and Painting (RRP) Rule establishes requirements for firms and individuals performing renovations, and affects contractors, property managers, and others who disturb painted surfaces. It applies to work in houses, apartments, and child-occupied facilities (such as schools and day-care centers) built before 1978. It includes pre-renovation education requirements as well as training, firm certification, and work practice requirements.

Shroud - a protective covering that contains dust and chips.

Tack pad - a sticky pad that helps remove dust from the soles of shoes.

Window trough - the area of the sill between a window stool or interior sill and the frame of the storm window where the bottom sash rests when closed (also called a window well or exterior sill).

FOR MORE INFORMATION

This section lists federal agencies' useful publications and contacts.

These documents can be found on the web by doing a search of the title. They are all housed on HUD's, EPA's, or OSHA's websites.

Publications

- [*Guidelines for the Evaluation and Control of Lead-Based Paint Hazards in Housing*](#) (2012). Technical guidance on methods for identifying and controlling lead-based paint and lead-based paint hazards. The Guidelines can also be downloaded for free from the HUD Office of Lead Hazard Control and Healthy Homes web site.
- [*Lead in Construction*](#) (2004). Guidebook that describes worker protection measures needed to meet OSHA requirements for lead including respiratory protection and protective clothing.
- [*The Lead-Safe Certified Guide to Renovate Right*](#) (September 2011). Pamphlet for pre-1978 contractors, homeowners, tenants, and child care facilities with basic facts about lead renovation information.
- [*Protect Your Family from Lead in Your Home*](#) (June 2017). Pamphlet that provides basic information about addressing and preventing lead-based paint hazards in the home.
- [*Steps to Lead Safe Renovation, Repair and Painting*](#) (October 2011). Guide for contractors/homeowners on how to plan for and complete a home renovation, repair or painting project in pre-1978 housing and child-occupied facilities using lead-safe work practices.
- [*Small Entity Compliance Guide to Renovate Right: EPA's Lead-Based Paint Renovation, Repair, and Painting Program*](#) (September 2011). A handbook for contractors, property managers and maintenance personnel working in homes and child-occupied facilities built before 1978.

- [Sample Pre-Renovation Form Confirmation of Receipt of Lead Pamphlet](#). This sample form may be used by firms to document compliance with the requirements of the federal lead-based paint renovation, repair, and painting rule.
- [Sample Renovation Recordkeeping Checklist](#). Sample checklist for regulated RRP activities.

CONTACTS

The phone numbers below can be reached by people with hearing or speech difficulties through the FedRelay Service through teletype (TTY) at 800-877-8339.

U.S. Department of Labor
Occupational Safety and Health Administration (OSHA)
Publications Office
200 Constitution Avenue, NW, Room N3626
Washington, DC 20210
Lead: www.osha.gov/SLTC/lead
Respirators: www.osha.gov/SLTC/respiratoryprotection

U.S. Environmental Protection Agency (EPA)
Office of Pollution Prevention and Toxics (OPPT)
1200 Pennsylvania Ave, N.W.
Washington, DC 20460
www.epa.gov/lead
National Lead Information Center (NLIC)
1-800-424-Lead (1-800-424-5323)
www.epa.gov/lead/forms/lead-hotline-national-lead-information-center

U.S. Dept. of Health and Human Services (HHS)
Centers for Disease Control and Prevention (CDC)
Agency for Toxic Substances and Disease Registry (ATSDR)
4770 Buford Hwy NE
Atlanta, GA 30341
800-232-4636
www.atsdr.cdc.gov/substances/toxsubstance.asp?toxid=22

Centers for Disease Control and Prevention (CDC)
National Center for Environmental Health (NCEH)
4770 Buford Hwy NE
Atlanta, GA 30341
800-232-4636
www.cdc.gov/nceh/lead

Centers for Disease Control and Prevention (CDC)
National Institute of Occupational Safety and Health (NIOSH)
Hubert H. Humphrey Building, Room 7154
200 Independence Avenue, SW
Washington, DC 20201
800-232-4636
www.cdc.gov/niosh/topics/lead

National Institutes of Health (NIH)
National Institute of Environmental Health Sciences (NIEHS)
105 T. W. Alexander Drive
Research Triangle Park, NC 27709
www.niehs.nih.gov/health/topics/agents/lead

U.S. Dept. of Housing and Urban Development (HUD)
Office of Lead Hazard Control and Healthy Homes
451 7th Street, SW Room 8236
Washington, DC 20410
202-402-7698
www.hud.gov/healthyhomes

GETTING THE WORD OUT

How Owners and Occupants Can Work Together to Improve Lead Safety in Homes

Gaining tenant cooperation can help rental property owners and managers respond promptly to conditions that could pose a health threat to occupants.

Owner Responsibilities

1. Maintain renovation firm certification, or use only certified renovation firms for maintenance work as required. When renovation, repair or painting work will be done, notify tenants and provide them (or have the contractor notify and provide them) with the Lead-Safe Certified Guide to Renovate Right: Important Lead Hazard Information for Families, Child Care Providers and Schools, also known as the "Renovate Right" pamphlet.
2. Maintain the building.
 - Ensure maintenance supervisors are trained and RRP-certified, and that workers are trained as required to minimize dust, clean up effectively, and protect themselves.
 - Conduct regular building checks for potential problems, such as:
 - Flaking or peeling paint
 - Water damage to paint, plaster, or wood
 - Plumbing or roof leaks
 - Painted doors and windows that do not operate smoothly
 - Building shell issues including leaks
 - Interior moisture causing damage
 - Dirty and un-cleanable surfaces
3. Educate occupants and gain their cooperation.
 - Fulfill federal notice and disclosure requirements.
 - Have occupants inform you of damaged paint and other maintenance problems.
 - Explain to occupants why steps, such as regular cleaning, prevent lead-based paint hazards (see below).
 - Consider providing cleaning supplies and tools (*see p. 78*) to occupants to encourage cleaning.

- Remind occupants that it is a good practice to provide notice of problems in writing.
- Make sure occupants understand the property's maintenance reporting procedures and indicate that these problems require priority attention.

Precautions Tenants Can Take to Protect Their Family

Occupants should pay special attention to the pamphlet "Protect Your Family from Lead in Your Home" (*p. 64*). It describes steps that occupants can take to reduce the chance that they will be exposed to lead hazards. Suggestions from this pamphlet include:

- Clean floors, window frames, interior window sills, and other flat surfaces each week using warm water and an all-purpose cleaner.
- Clean up any paint chips immediately.
- Keep child play areas clean.
- Wash children's hands often.
- Keep children from chewing interior window sills and other painted surfaces.

Federal Lead Disclosure Requirements for most pre-1978 Homes (24 CFR Part 35, Subpart A, or 40 CFR Part 745, Subpart F)

- Landlords and home sellers must notify future occupants about lead-based paint hazards by giving them the pamphlet *Protect Your Family from Lead in Your Home*.
- Landlords and home sellers must disclose information about known lead-based paint and/or lead-based paint hazards before dwelling leases or home sales contracts take effect. Leases and sales contracts must also include a form about lead-based paint that meets federal requirements. Contact HUD or EPA for more information about these requirements (*see p. 66*).

Pre-Renovation Education Requirements

The pre-renovation education requirements of the Renovation, Repair and Painting Rule ensure that owners and occupants of most pre-1978 homes and child-occupied facilities are provided information about potential hazards of lead-based paint exposure before renovations are begun.

What are the requirements? The rule requires distributing the pamphlet, "The Lead-Safe Certified Guide to Renovate Right: Important Lead Hazard Information for Families, Child Care Providers and Schools," also known as the "Renovate Right" pamphlet, to tenants or child-care center children's families, before the work starts.

- In housing built before 1978, the contractor must distribute EPA's lead pamphlet to the owner and occupants before renovation starts.
- For work in common areas of multi-family housing, the contractor must either distribute renovation notices to tenants or post informational signs about the renovation or repair job.
- In a child-occupied facility the contractor must distribute the lead pamphlet to the owner of the building and an adult representative of the child-occupied facility before the renovation starts. Also, the contractor must either distribute renovation notices to parents/guardians of the children attending the child-occupied facility, or post informational signs about the renovation or repair job.
- The contractor must obtain confirmation that the owner and the housing occupants received the lead pamphlet or obtain certificate(s) of mailing from the post office. The contractor may also certify in writing that the lead pamphlet was delivered but written confirmation was not received.
- Retain records for at least three years.

How do I get the "Renovate Right" pamphlet? You can download the pamphlet from EPA's website at www.epa.gov/lead. Single copies of the pamphlet are available from the National Lead Information Center at 1-800-424-LEAD (5323). For multiple copies contact the Government Publishing Office (GPO) at <http://bookstore.gpo.gov/> or (202) 512-1800.

The phone numbers above can be reached by people with hearing or speech difficulties through the FedRelay Service through teletype (TTY) at 800-877-8339.

Note: In federally assisted pre-1978 housing, HUD requires notification to be distributed to occupants within 15 days after lead-based paint or lead-based paint hazards are identified in their unit (or common areas, if applicable), and within 15 days after completion of hazard control work in their unit or common areas.

Why Lead Safety Makes Sense for Property Owners and Contractors

Property owners and contractors that use safe work practices benefit in several ways.

Advantages for Owners of Residential Rental Properties

Owners who maintain their rental properties using work practices that increase lead safety can use this information to attract tenants who are concerned for their child's health. Some local agencies may even maintain a listing of housing units that meet certain lead-safety standards. When giving prospective tenants the lead-based paint pamphlet and the required disclosure information, they can tell the tenant that the property has a program to minimize the risk of hazards from lead-based paint. A safety program would include:

- Educating and training maintenance workers.
- Examining property at turnover and then every year for deteriorating paint.
- Correcting conditions that may cause paint to flake and peel (excessive moisture, binding doors, etc.).
- Doing work safely and cleaning up well.
- Making sure surfaces are cleanable and doing a professional cleaning at turnover.
- Performing dust wipe tests before occupancy, and after every maintenance job that disturbs old paint. It is also recommended to perform a dust wipe sample test at least every two years. Keep the results on file.
- Encouraging tenants to inform property owners if there is a problem.

Advantages for Contractors

Doing work safely can enhance a contractor's reputation, maintain the safety of workers, and protect the health of customers and their children.

A program for lead safety can also help contractors when bidding new jobs. For example, contractors performing repairs and improvements in homes built before 1978 must give potential customers a pamphlet about the risk of lead-based paint during renovation. Contractors that follow practices for lead safety can demonstrate to customers that they understand the risks and show that their workers take specific precautions to protect against lead-based paint hazards. Lead safety can help "give you a leg up" on the competition.

Safe work practices also offer benefits that are important to customers:

- Dust and debris are confined to the work area.
- A "clean" work area at the end of the job.
- Some work offers additional benefits (for example, repairs to windows can improve their operation, prevent damage from moisture, and lower energy and maintenance costs).
- Lead safety also helps protect you as a contractor. For example, having an independent, certified professional take dust wipe samples of the work area promptly after cleanup provides strong documentation that no lead hazards were present in the work area at the end of the job.

MORE ABOUT TECHNICAL TOPICS

Respiratory Protection

Respiratory protection helps prevent workers from breathing harmful amounts of lead and other substances, touching their mouths with dusty hands, or swallowing paint chips or dust.

When work creates high levels of dust in the air, properly trained, protected, and certified lead-based paint professionals should conduct the work. See OSHA's Lead in Construction Standard, 29 CFR 1926.62.

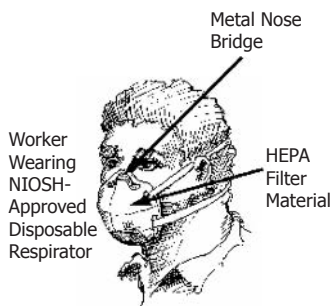

See p. 61, for information about OSHA regulations, and see the bottom of www.osha.gov/SLTC/lead/exposurecontrols.html for information on controlling workers' exposure to lead.

Other Protection

In addition to respiratory protection for activities that generate high levels of dust, compliance with OSHA's Lead in Construction Standard may involve blood tests for workers, medical monitoring, hand washing facilities, other personal protective equipment, shower and changing areas, and additional training.

ENSURING THE PROPERTY IS CLEAN

To ensure work areas are safe for re-occupancy, confirm that the property has been properly cleaned and no lead hazards remain. Cleaning verification is required by the Renovation, Repair and Painting Rule. If the housing receives federal assistance, clearance testing is required. When the cleaning verification procedure is required, an EPA Certified Renovator must perform the cleaning verification. If clearance is required, a Certified Lead Inspector, Certified Lead Risk Assessor, or Certified Lead Sampling Technician must conduct clearance testing.

Cleaning Verification

Cleaning Verification Procedure:

After completion of cleaning, the Certified Renovator must visually inspect the work area to confirm that it is free of dust, debris, or residue.

For exterior projects, when work areas have passed the visual inspection, the project is complete, and the area may be turned over to the occupants.

For interior projects:

- When work areas have passed the visual inspection, the cleaning verification procedure is performed by a renovator certified by EPA or an EPA authorized state.
- Cleaning verification involves wiping all dust collection surfaces in the work area with a wet, disposable cleaning cloth and comparing that cloth visually to a cleaning verification card. If the cloth is not cleaner than the card the area must be re-cleaned, and the cleaning verification step must be repeated. If the cloth is still not as clean as the card the renovator must wait one hour and wipe the area with a dry electrostatic cloth. When all surfaces have passed comparison with the card or completed the verification procedure the area can be turned back over to residents.

Cleaning verification cards are available by calling the National Lead Information Center at 1-800-424-LEAD (5323). The phone number can be reached by people with hearing or speech difficulties through phone or teletype (TTY) at 711.

Note: For surface areas greater than 40 square feet, the area must be divided into roughly equal sections that are 40 square feet or less. Wipe each section separately using a new wet disposable cleaning cloth for each separate section.

Clearance Testing

By having dust wipe samples taken and tested by an [EPA-recognized lead laboratory](#), job supervisors, certified renovators and property owners can locate dust lead hazards and test the effectiveness of cleaning at the end of a job. If federal funds are involved, clearance is required.

Where Are Dust Samples Taken?

Samples are taken in the area of the dwelling where work has been completed. The following surfaces within the work area should be sampled:

- Floor
- Interior window sills (also referred to as window stools)
- Window troughs (where the bottom of the window sash meets the frame)

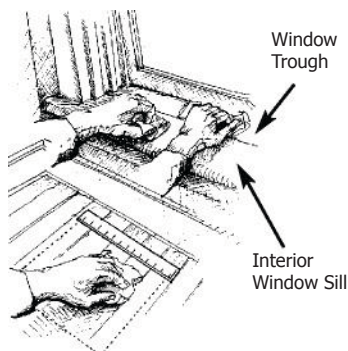

When Should Dust Samples Be Taken?

- At the end of a job, after the project has passed visual inspection of the work area to confirm that it is free of dust, debris, or residue
- If there is a child or pregnant woman living in the home
- Before a family moves into a home
- Following work in homes receiving federal assistance

What Do the Results Mean?

The results of the laboratory analysis will show the amount of lead found in the dust from the area sampled. The results are measured in micrograms per square foot ($\mu\text{g}/\text{ft}^2$).

To determine if the project has passed clearance regarding dust lead levels, based on EPA's requirements, determine if the results are below the following standards (in effect as of 2018):

- 40 $\mu\text{g}/\text{ft}^2$ on floors
- 250 $\mu\text{g}/\text{ft}^2$ on interior window sills
- 400 $\mu\text{g}/\text{ft}^2$ on window troughs

For work done under HUD's lead hazard control grants, determine if the results are below the following action levels (also as of 2018):

- 10 $\mu\text{g}/\text{ft}^2$ on interior floors
- 40 $\mu\text{g}/\text{ft}^2$ on porch floors
- 100 $\mu\text{g}/\text{ft}^2$ on interior window sills
- 100 $\mu\text{g}/\text{ft}^2$ on window troughs

Who Can Take Dust Wipe Samples?

Following painting, home maintenance, and renovation work:

- Where dust wipe sampling is elected or required by regulations, sampling must be done by appropriately trained personnel. This clearance testing may be done by a lead-based paint inspector, risk assessor, or sampling technician certified by a State or the EPA. Check your state's requirements. Note: In federally assisted housing, the individual performing sampling cannot have been involved in the work.

What Actions Do I Take Based on the Results?

If the results show dust lead levels equal to or higher than the standards or action levels listed above, the area where the work was performed should be re-cleaned until dust clearance sample results are below the applicable clearance or action standard.

If the dust wipe samples were taken as part of ongoing monitoring by maintenance staff or the property owner, the surfaces where work was performed should be examined to see if the work has failed or new conditions that generate dust have developed. In either case, these conditions should be corrected using lead-safety principles and work practices.

If the work required to correct the likely source of the dust lead hazard is beyond the scope of this guide, the property owner should seek the help of a lead-based paint professional trained to safely correct lead-based paint hazards.

WORKSITE CHECKLISTS

Before Work Begins

- Has the paint that will be disturbed been tested to determine if it is lead-based paint, or is it assumed to be lead-based paint?
- Have the owner(s) and/or occupant(s) been notified as required by federal law? (see p. 69)
- Are the causes of the problems located?
- Is the firm conducting the work and the project supervisor certified for RRP work by EPA or an EPA-authorized state, and have the workers been trained in lead-safe work practices?
- Have the supplies needed for the project been brought to the worksite? (See supplies checklist below)
- Is the work area set up?
- Is the work area closed off from occupant(s), with lead warning sign(s)?

During Work

- Are dust and debris contained so that no dust or debris leaves the work area?
- Are workers wearing necessary protective clothing and equipment?
- Are all workers, tools and other items free of dust and debris when leaving the work area?
- Is all waste contained and stored to prevent access and the release of dust and debris?

At the End of the Job

- Did workers fix the cause of the problem?
- Did workers remove visible dust and debris?
- Did workers properly dispose of dust and debris?
- Did workers clean the work area until no dust, debris or residue remained?
- Was cleaning verification or dust sampling performed by qualified individuals to make sure that cleanup worked?

For Long-Term Maintenance

Is there a plan to:

- Maintain painted surfaces?
- Keep surfaces clean and cleanable?
- Prevent water and moisture damage?

Supplies Checklist (Note that not all items are needed for all jobs)

Set Up

- Signs
- Barrier tape, rope, or fencing
- Cones
- Heavy-duty plastic sheeting
- Tape (masking, duct, or painter's)
- Stapler
- Utility knife or scissors
- Rigid framing material for vertical containment

Protect Yourself

- Painter's hat
- Disposable coveralls
- Disposable N, P, or R-100 rated respirator
- Disposable shoe covers
- Safety glasses
- Ear protection if using power tools

Safety station with:

- Paper towels and hand soap
- 2-bottle eye-wash station
- First aid kit
- Clipboard with emergency numbers
- Drinking water and cups

Minimize the Dust

- Wet-dry sandpaper, sanding sponge
- Misting bottle or pump sprayer
- Paint scrapers
- Plane: jack, smooth or jointer
- HEPA filter equipped vacuum ("HEPA vacuum;" "HEPA vac")
- Heavy-duty plastic bags
- Tack pads (large, sticky pads that help remove dust)
- Paper towels, or disposable wipes

Other tools that may be needed:

- Low-temperature heat gun (under 1,100 degrees Fahrenheit)
- Chemical strippers without methylene chloride
- Power tools with HEPA filter equipped vacuum attachments

Clean Up

- Disposable wet-cleaning wipes or hand towels
- General-purpose cleaner
- Mop and disposable mop heads
- Two buckets or one two-sided bucket with a wringer
- Shovel and rake
- Electrostatically-charged dry cleaning cloths
- HEPA filter equipped vacuum

This Guide may be reproduced and distributed without prior permission from the U.S. Department of Housing and Urban Development or any other federal agency.

Disclaimer: The guidance offered in this document is based upon the latest lead hazard control knowledge and technology available at the time it was written. Users bear all risks associated with reliance on these work practices and have sole responsibility for evaluating the information it contains. Users bear sole responsibility to form their own independent judgments on the document's use, modification, and adaptation as appropriate. Neither the United States Government nor any of its employees makes any warranty, expressed or implied, or assumes any legal liability for any use of, or the results of, any information, product, or process discussed in this document.

Why Follow this Guide?

The Simple Work Practices discussed in this Field Guide can protect children and workers

- This Field Guide contains practical steps for lead safety.
- With small changes from traditional work practices, workers can protect themselves, their families, and their customers, especially children, from lead exposure.

Painting, Home Improvement, and Maintenance Work in Older Homes Can Endanger Children

- Most homes built before 1978 contain lead-based paint
- Doing work improperly can create a lot of paint chips and dust that may contain lead
- Lead in paint chips, dust, and soil gets on children's hands and toys which they may put in their mouths
- Lead can make children very sick and cause permanent brain and nerve damage, learning difficulties, and behavior problems

Poor Maintenance Also Endangers Children

- Paint flaking and peeling is often caused by moisture
- Rubbing or impact on doors, windows, and trim can cause paint failure and produce lead-containing dust

Who Should Use This Guide?

- Maintenance Contractors
- Building maintenance staff
- Property managers and owners
- Homeowners hiring contractors or doing work on their own residences
- Local public housing agency staff
- Local public health agency staff
- Volunteers
- Contractors working in federally assisted housing

Ordering Additional Copies

Single printed copies of this publication can be ordered from the National Lead Information Center at 1-800-424-5323 (TTY: 800-877-8339). For persons with speech or hearing disabilities, call 711. You can download this publication from the HUD Office of Lead Hazard Control and Healthy Homes website at www.hud.gov/healthyhomes.

